

Network Camera Firmware Upgrade

Quick Guide

09-2018 / v1.0

Edimax Technology Co., Ltd.

No. 278, Xinhua 1st Rd., Neihu Dist., Taipei City, Taiwan

Email: support@edimax.com.tw

Edimax Technology Europe B.V.

Fijenhof 2, 5652 AE Eindhoven, The Netherlands

Email: support@edimax.nl

Edimax Computer Company

3350 Scott Blvd., Bldg.15 Santa Clara, CA 95054, USA

Live Tech Support: 1(800) 652-6776

Email: support@edimax.com

CONTENTS

<i>I Introduction</i>	3
<i>II How to Upgrade Firmware for Network Camera</i>	4
<i>III Download App</i>	11

I Introduction

To strengthen the security of your network camera, please visit Edimax website to download the most up-to-date firmware for your device. This quick guide will use IC-7113W as an example to show you how to upgrade the network camera firmware step by step.

1. Download the latest firmware from the Edimax website.
2. Reset IC-7113W to its factory default setting.
3. Configure static IP and web log in page on the computer.
4. Upgrade firmware version through browser.
5. Reset IC-7113W to its factory default setting again, then install EdiLife app.

Before you begin, make sure you have met the following requirements.

- Desktop or laptop:
 - Intel Pentium 4 2.4GHz (above or similar),
 - VGA card (1024*768 or above)
 - At least 128MB hard disk space (256 MB recommended)
 - Windows XP, Vista, 7, 8, or 10, Mac OS X
 - Web browser (Internet Explorer 7.0, Firefox 3.6, Chrome 10, Opera 11, Safari 5 or above)
 - LAN Port
- Internet
- Ethernet Cable
- And a mobile phone for app download

Note: This quick guide for firmware upgrade is also applicable with the following network cameras. Some steps may vary by models, please refer to their online manuals respectively.

- IC-9110W
- IC-7113W
- IC-3140W
- IC-7112W
- IC-3116W

II How to Upgrade Firmware for Network Camera

1. Please visit www.edimax.com via desktop or laptop, select “**Support & Services**” - “**Download**”, then enter the network camera model number, “**IC-7113W**” or other applicable device model number in the **search box** to look for its firmware. Please refer to screen shot below for instructions.

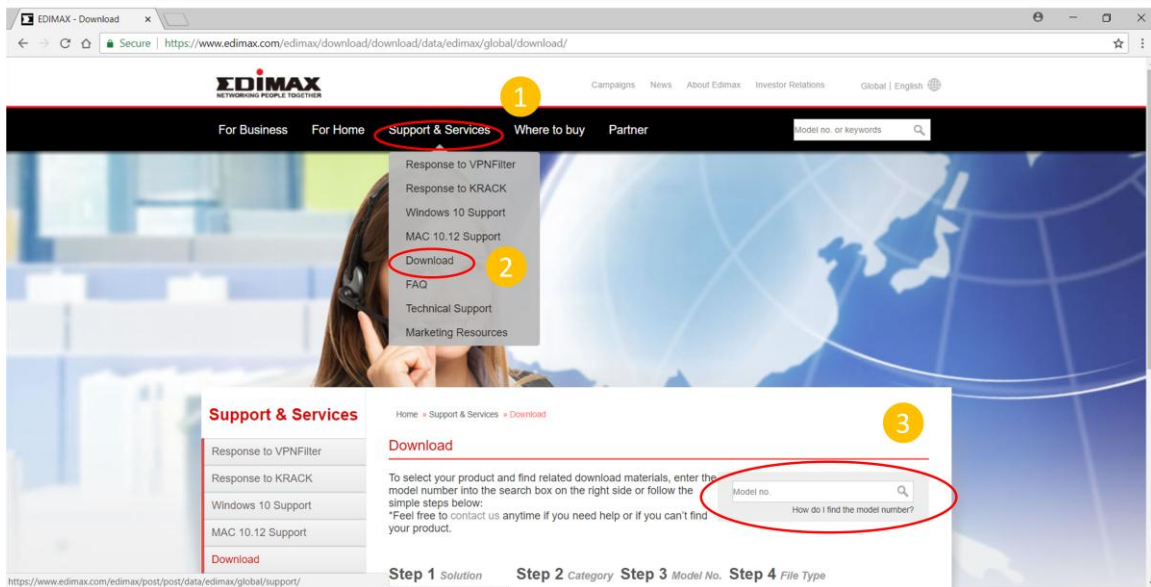

Download

To select your product and find related download materials, enter the model number into the search box on the right side or follow the simple steps below:
*Feel free to contact us anytime if you need help or if you can't find your product.

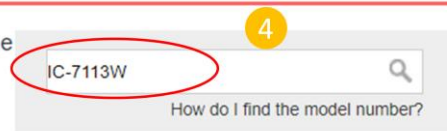

Click on IC-7113W as shown in red circle below to enter the download page of that product, then select the **download icon** on the far right of Firmware version 3.10 (as shown in red circle) to download the latest firmware.

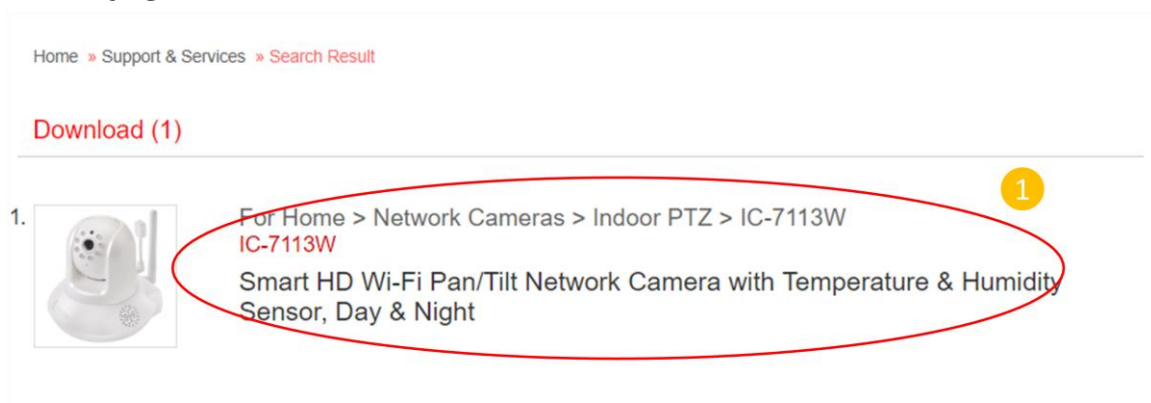

Firmware

Version ^	Note	Date	File Type	File Size	
3.10	1. Patch cracks wpa2 issue.	2018-05-24	ZIP	6.99 MB	 2

▲Top

Please refer to the figure below, copy the firmware file to designated directory. You can choose to save the file to desktop or IC-7113W folder under Drive (C:). (You can save the file first then unzip the zip file). Then right click on the mouse on IC-7113W_3.10.bin and select “copy”

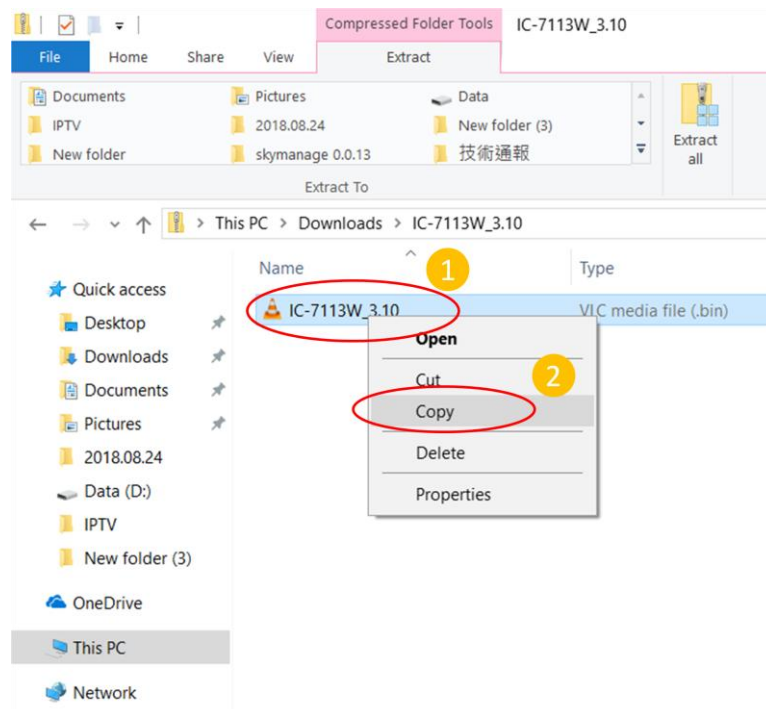

Click on “This PC” to find the directory where you want to save the copied firmware file, then right click on the mouse and “paste” the file.

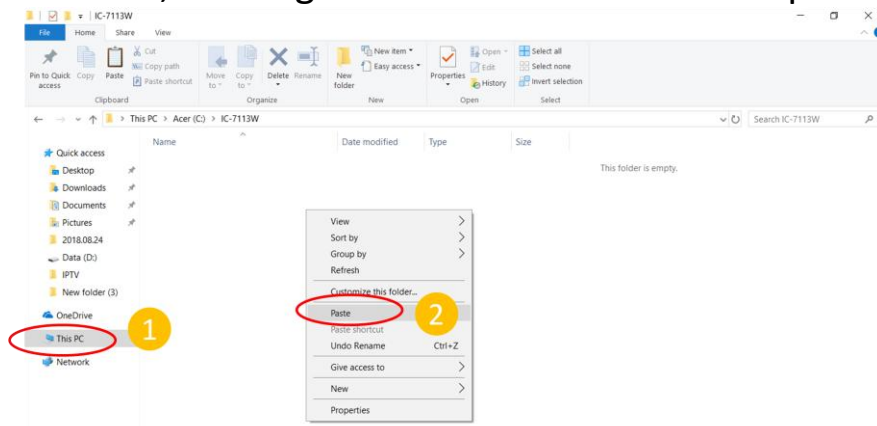

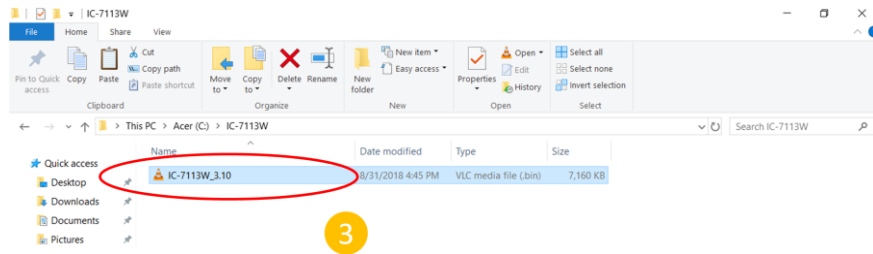

2. To reset to factory default setting, please follow the steps below. Please connect AC power adaptor to IC-7113W, then press and hold the WPS/Reset button found on the back panel for at least 15 seconds. Release the button when the LED is **flashing quickly red**.

Please wait for IC-7113W to reactivate, wait for the network camera to restart. The camera is ready when the LED is **flashing slowly red** and plays an audio tone from its speaker.

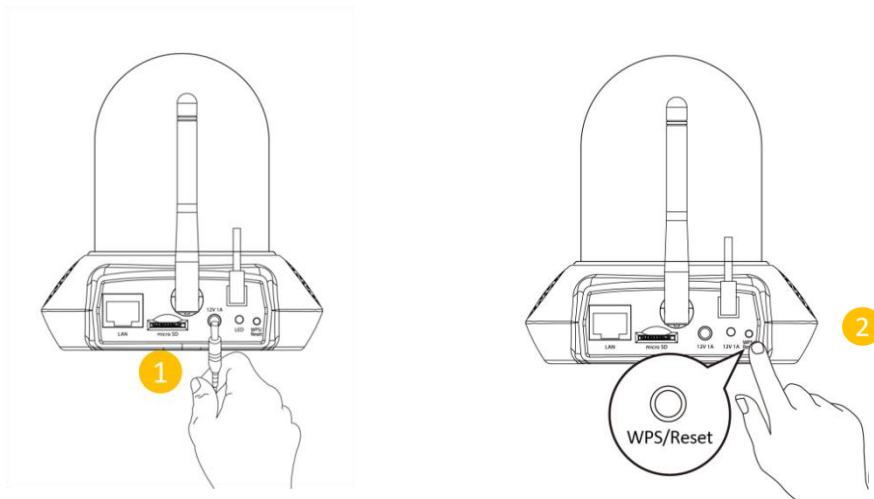

Note: This step may vary depending on your device model. Please refer to the user manual of your network camera.

3. Please refer to figure below and configure the LAN IP of desktop or laptop to static IP, such as: 192.168.2.4, the subnet mask is 255.255.255.0, default gateway is 192.168.2.2, etc. Using windows 10 as an example, click “start”, enter “settings”, “Network & Internet”, “Change adapter settings”.

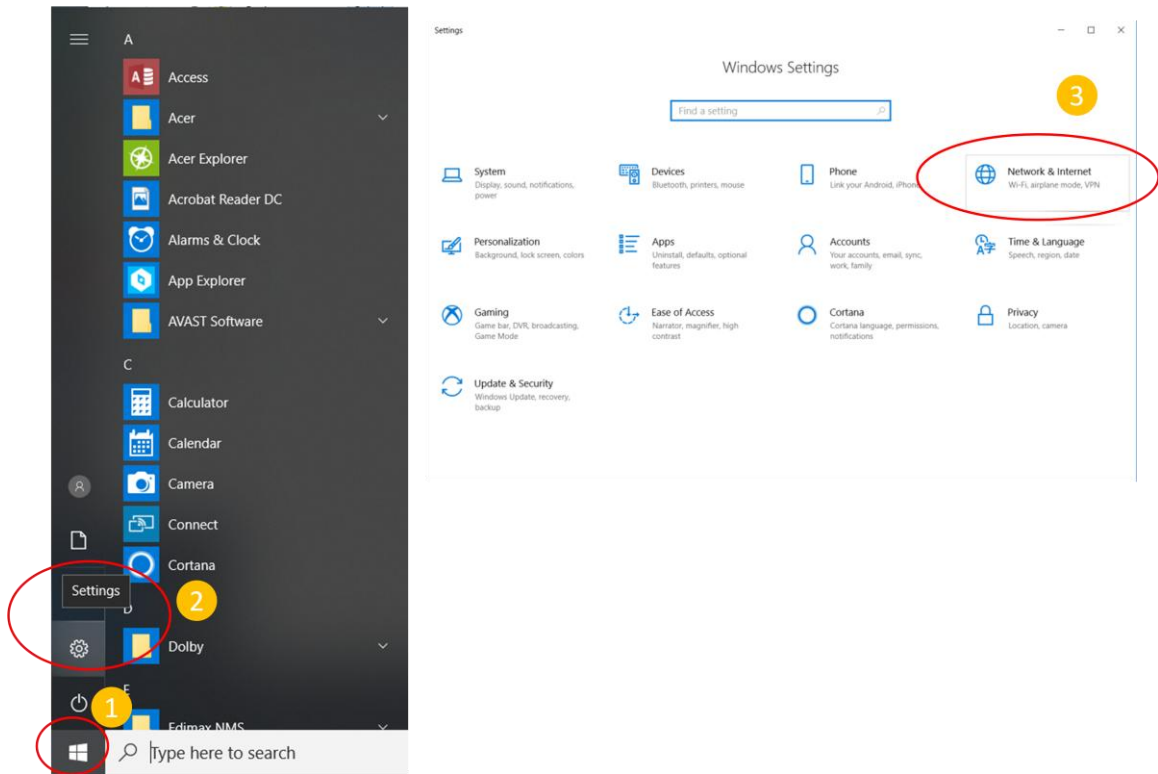

Left click to select "Ethernet" and right click on the mouse, the figure below appears, select "Properties", "Internet Protocol Version 4 (TCP/IPv4)", then click on "Properties" and configure according to the figure shown below. After filling out information, please click on "OK" to complete the configuration.

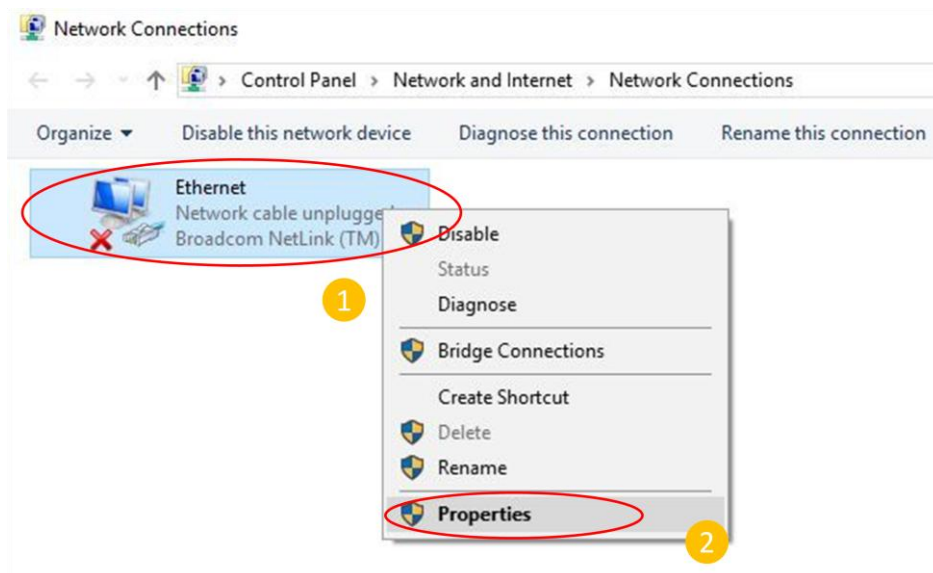

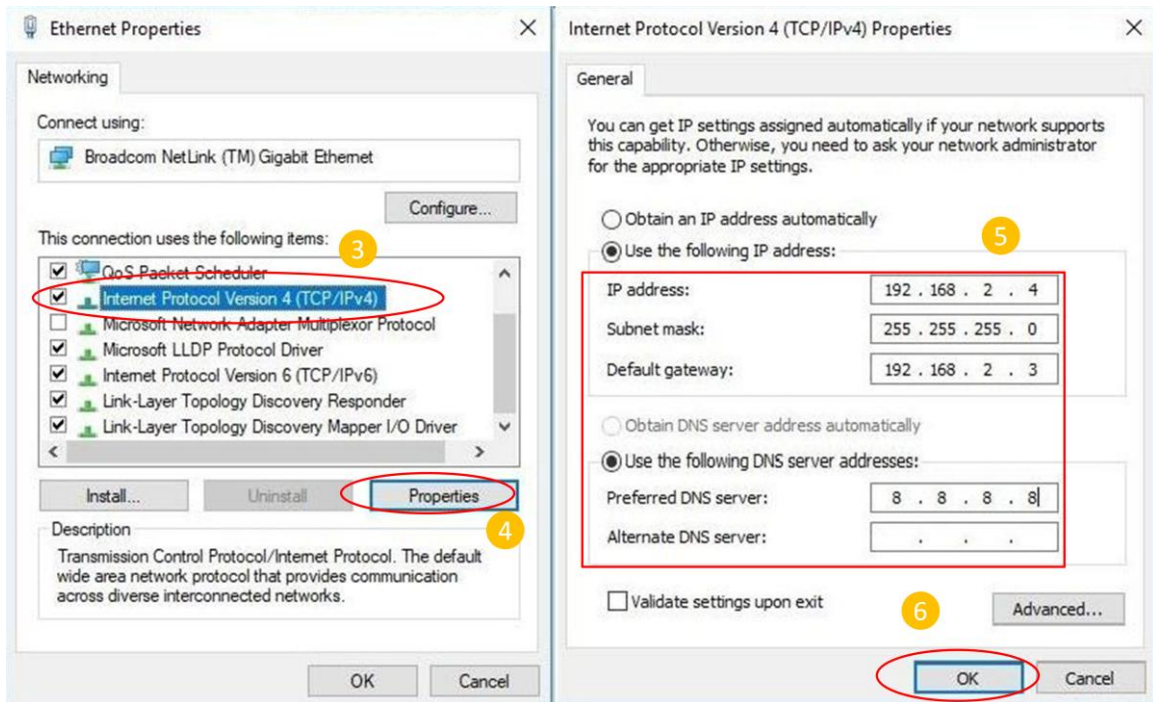

The next step, please connect your network camera to the desktop or laptop via an Ethernet cable.



Please start IE or Google Chrome or Firefox browsers, then enter the IP address 192.168.2.3 of IC-7113W in the address bar. When the below log in window appears, fill in the user name: admin, password: 1234, click "Sign in" to enter the web-based management interface of network camera.



Proceed to version upgrade according to following configuration steps. Then click on “Setup”.

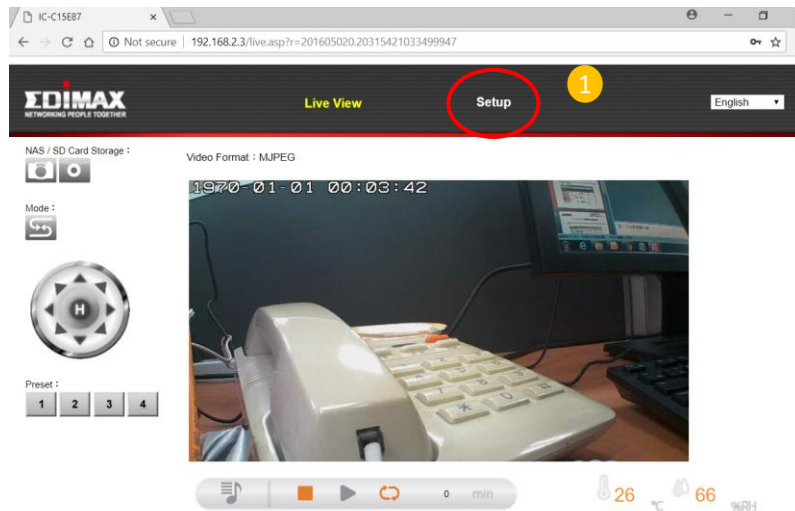

4. Then proceed to the upgrade firmware, select the “System”- “Advance” from the left side main menu, then select “Choose File” of Upgrade Firmware on the right side as figure shown below.

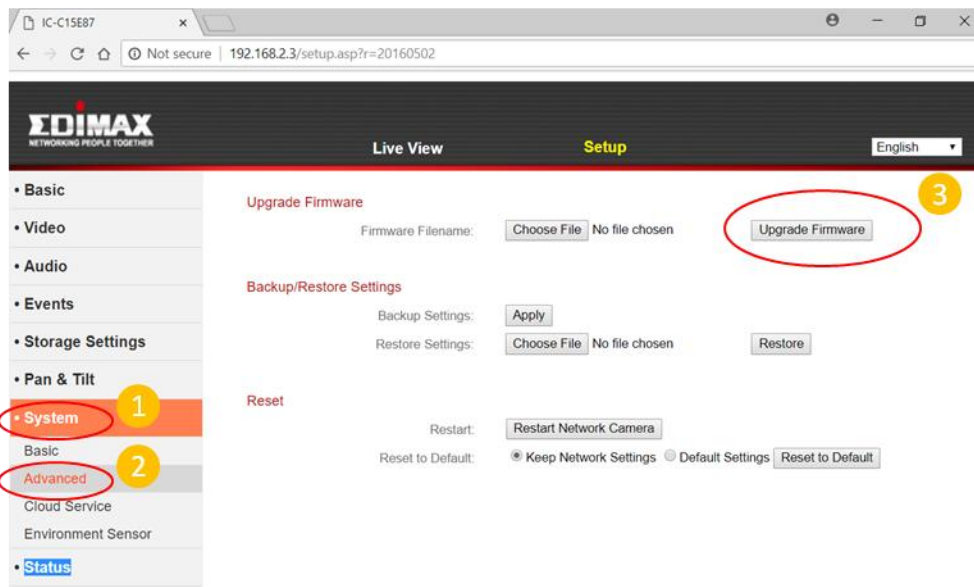

Please find the IC-7113W firmware file you saved in the step 1, select the file and click “Open”.

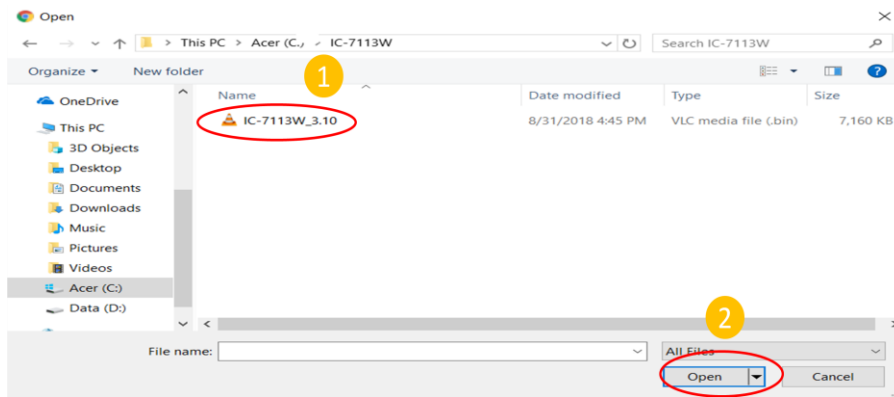

After confirming firmware is the right file, select “Upgrade Firmware” on the right side and system will upgrade itself. Please wait for the update completed and restart the network camera as figure shown below. (Please do not remove power cable and network cable)

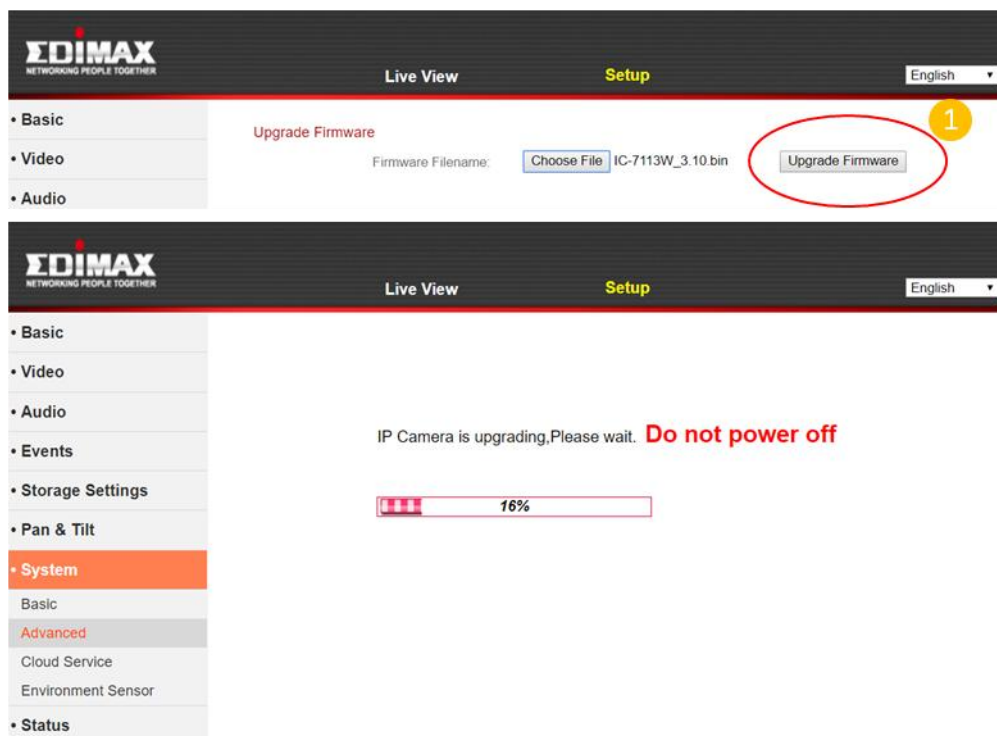

5. Due to changes in different firmware versions, please reset to factory default settings again. You can refer to “step 2” on page 6 to proceed. After your network camera has been reset to factory default setting, please configure the settings according to IC-7113W which are available on the Edimax website.

Congratulations! The firmware upgrade is complete!

III Download App

Use a smartphone or tablet to search, download and install the EdiLife app from Google Play or the Apple App Store.



For more information on how to set up your network camera over Wi-Fi using the EdiLife app, please refer to the online installation guide on the Edimax website by look up the device model number.



EDIMAX
NETWORKING PEOPLE TOGETHER

The logo is centered on a black horizontal band. The word 'EDIMAX' is in a bold, white, sans-serif font, with a small red dot above the 'i'. Below it, the tagline 'NETWORKING PEOPLE TOGETHER' is written in a smaller, white, sans-serif font. The background of the band is filled with various white line-art icons, including a handshake, musical notes, a smiley face, a game controller, a laptop, and a network diagram.